

The Reconstruction of the Medieval Unit of length Based on the Sizes of Contemporary Round Churches

Key words: etalon, length unit, round church, regression circle, total station

SUMMARY

There was an independent unit of length in Hungary between the 11th and 16th centuries, the so called royal fathom – the etalon of that was kept in Székesfehérvár. The etalon of this unit was lost, only a cord was found in 1960-ies, representing the original length, which is about 3.126 metres. The 1/10 part of the fathom is the royal foot and the 1/16 part of the fathom (the royal span) was published in statute books.

In our paper we want to demonstrate that the contemporary length unit was used for building churches at that time because the sizes of the buildings correspond to an ancient unit. Especially the round churches (rotundas) are interesting from this point of view. The main question is to choose the right building and the right measuring technology. We need a continuous, adjusted control point network based on direction and distance measurement both inside and outside the building. The measures of buildings can be obtained by precise methods, for example the radius of the circle with adjustments.

After constructing the floor plan, we match standard building measurements to the former units of length. We try to make a floor plan that is similar to what the original could have been where standard measures were probably given in integer multiples of the foot or span.

We precisely measured seven Hungarian medieval rotundas situated at five Hungarian, one Slovakian and one Slovenian settlements and we have reconstructed (clarified) the length of the royal fathom.

The Reconstruction of the Medieval Unit of length Based on the Sizes of Contemporary Round Churches

1 INTRODUCTION

As a result of standardisation, distance data, i.e. lengths are given uniformly in a metre-based system all over the world. Today, the definition of the metre, a unit of length as such, is traced back to the wavelength of light. In the beginning, the etalon was made in the shape of a metal bar. Before the metric system was introduced, the Vienna fathom had been the official unit of length in Hungary, like in all the countries within the Habsburg Empire.

Certificates confirm that there used to be an independent Hungarian length measurement system in medieval Hungary. Its etalon hasn't survived. Moreover, the memory of its existence has since then disappeared from the common knowledge, too.

This article presents the survey methodology, ie. traverse survey which led to our attempts to restore the medieval Hungarian standard unit of length. The fundamental idea behind our work is that large buildings were designed and constructed on the basis of architectural plans even in the Middle Ages, which must have been carried out with units of length. We can also assume that the sizes of buildings were mostly given in integer multiples of the measurement. If we manage to determine the measurements of a chosen building that has been preserved in its original form, we may get the original unit of length in a metric system. Round churches which were built in the 10th century in numerous settlements in Central Europe are particularly suitable for the subject of such geometric, floor plan analyses.

Archaeometry is the study of cultural heritage objects using natural scientific tools. The natural sciences (physics, chemistry, biology, earth sciences, etc.) can often be effective in determining, for example, the age, material and provenance of an artefact. Examples include dendrochronology, radiocarbon dating, genetics, and in our field, remote sensing or geophysical survey. We believe that our study can be included in this category. It is the contribution of surveying to a better understanding of the past, to help historians, archaeologists, metrologists, architects.

2 THE MEDIEVAL HUNGARIAN SYSTEM OF LENGTH

2.1 The names and conversion factors of the medieval units of length, based on the archives

We know little about the history of the Hungarian units of length used in the Middle Ages. Their emergence must have been influenced by the Greek, Roman and Eastern cultures. It is likely that these units of length emerged from the actual sizes of human nave parts, which their original names also suggest.

The smallest natural unit of length is the *finger*, which corresponds to the width of an index finger or the overall width of 4 barley seeds placed widthways next to one another. The *inch* corresponds to the width of a man's thumb. The *palm* is a unit of distance that corresponds to the width of 4 fingers. The *foot* is a unit that has Greco-Roman origins. It doesn't correspond to the average length of a human foot but 16 fingers or 12 inches. The Hungarian large *span* is the tips between a grown-up man's extended little finger and thumb, it makes 10 fingers.

The *fathom* comes from the distance of a grown-up man's extended arms. The English and German or Austrian (and others) fathom measures 6 feet. However, the Hungarian royal fathom makes 10 feet, i.e. it is of different size than the aforementioned ones. We know the conversion factors above thanks to the research by *István Bogdán* [1] and they are displayed in *Table 1*.

TABLE I. THE MEDIEVAL HUNGARIAN UNITS OF LENGTH AND THEIR EXCHANGE FACTORS

	fathom	step	cubit	feet	span	palm	inch	finger
1 fathom	1		5	10	16	40	120	160
1 step		1		3		12	36	48
1 cubit			1	2		8	24	32
1 foot				1		4	12	16
1 span					1			10
1 palm						1	3	4
1 inch							1	4/3
1 finger								1

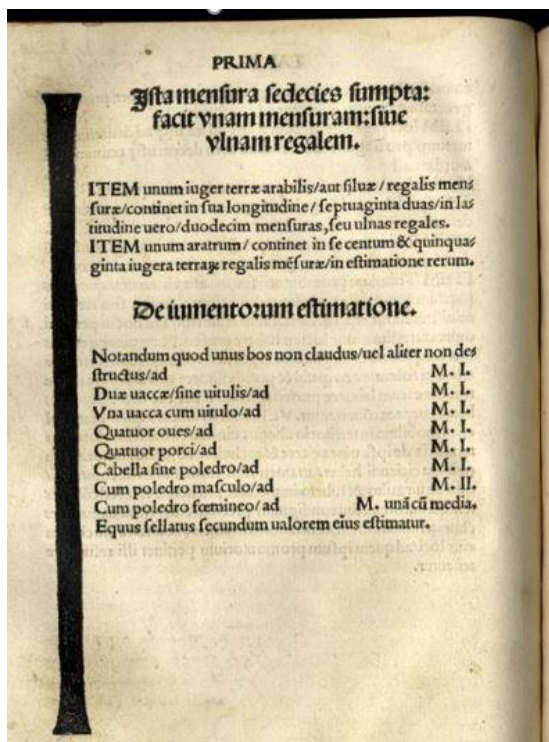

Fig.1. The length of the span in statute book

2.2 The metric length of the royal span

The Hungarian Royal units of length and area were first mentioned in *King Matthias'* statute book, and there were drawings as well because the royal span was displayed in its actual size on the side of the page. Although this statute book was reprinted in Leipzig in 1488, then in 1490, and a copy has survived, the length of the royal span cannot be measured. Sadly, the top edge of the relevant page was eaten by mice, the bottom edge was cut off by the binder's knife.

The later statute books, which are known as the *Tripartitum* by *Werbőczy* the length of the royal span can be measured using a millimetre ruler (*Fig. 1*). If we wanted to determine the length of the royal fathom from the size of the span above, we would get a value between 2.88 m and 3.07 m. We must come to the conclusion that this way the fathom cannot be determined precisely

enough – it is for informational purposes only. According to the legal text, the royal fathom is equal to the royal span times 16. The unit of area measurement is the royal jugerum-sized land (Hungarian: királyi hold), which is equal to the area of 12×72 royal fathom.

2.3 The metric length of the royal fathom

Unfortunately, no tangible memory of the etalon is existing, we know of one single copy to be precise, which turned up in the Hungarian central archives. This copy is a royal-fathom long measuring rope, which was attached to a report from 1702. Furthermore, a unit of length corresponding to one span was drawn in the report. The length of the measuring rope (the distance between the knots tied at the two endpoints of the rope) was measured in the Hungarian Metrology Office and it was said to be 3.126 m. This value is as the ‘official’ metric length of the medieval royal fathom. If the metric value of smaller units is derived from this, we get the following: 1 foot = 31.26 cm; 1 span = 19.54 cm.

3 THE POSSIBILITY OF USING CHURCH MEASUREMENT TO RESTORATION THE ROYAL FATHOM IN METER

3.1 Ancient churches as the guardians of the unit of length

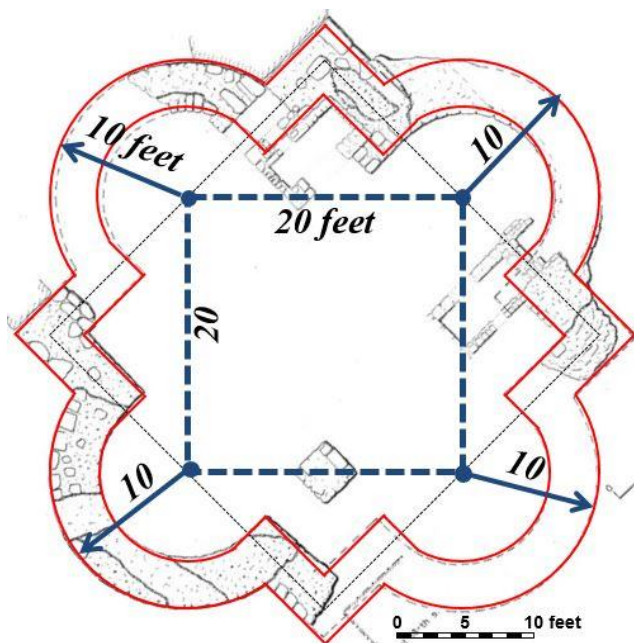

Fig.2. The sizes of the earliest church in Székesfehérvár in royal feet

Churches are objects usually made of symmetrical geometric shapes that have regular floor plans. We can assume that the marking/setting and the construction of these buildings required the use of plans or they can't have been built in such quality. We can also assume that during the design and the construction the key measures of buildings were provided in integer multiples of the unit of length. This simplifies work and is advantageous for practical reasons.

For example, we want to share the floor plan of one building and its measures expressed as royal feet (Fig. 2). This building was once situated at the highest point of Székesfehérvár and it was the oldest church in the city. It used to be a church with four vaults, its remaining base walls were excavated by archaeologist Alán Kralovánszky only in 1971 [2]. He reconstructed the design and building process of the regular

church and concluded that the outer radius of the vaults corresponded to exactly 1 royal fathom (10 feet).

3.2 The surveying procedure for measurements of round churches

Round churches are worth the attention for several reasons. In numerous countries all over Europe, especially in Central-Europe, the oldest churches of the 9th and 10th centuries were built to be circular and quite few are still standing. The circle is the simplest geometric shape. It was not only easy to draw with the aid of bows (*rondure*) on a piece of paper but it was possible to set out during field work – you needed only a string and two poles.

Round churches are advantageous in terms of size determination because in the simplest case there are at least two circles available to be studied – the circle of the outer wall and that of the inner wall. Nevertheless, the majority of round churches have a base that consists of two circles because the sanctuary and the nave are also rounded.

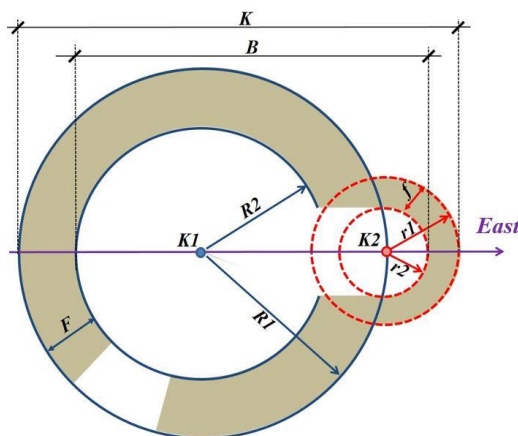

Fig.3. Typical round church floor plan

We talk about round churches closing in a semi-circular sanctuary when the centre of the church's arc lies on the inner arc of the nave (*Fig. 3*). The church is oriented East. It is worthwhile to measure the inner (B) and outer length (K) of the church. The wall thickness of the sanctuary (f) is often half of what the nave (F) possesses. A special group within round churches includes those with four vaults. We can determine not only several circles but also additional things because the location of the vault centres shows regularity.

3.3 The way of surveying round churches – the role of surveying profession

Our aim is twofold: first, to verify whether a length standard was actually in use in the Middle Ages, and second, to reconstruct the length of the standard. The tasks can be compared to the reverse engineering used in machinery: to measure an object and then produce the missing plans. To accurately measure a building inside and outside, only surveying technologies are suitable. The measurements in this case could be done with one of the following surveying technologies:

- 1) laser scanner survey (by static or mobile scanner)
- 2) photogrammetry (from ground or UAV images)
- 3) polar survey (with total station).

Each technology has its advantages and disadvantages. Comparing them is not our task here, but there is no doubt that the advantage of first two technologies is a very large number of points, the point cloud, from which we can select the ones that are important to us during processing. If we use a total station, we have to select the important points of the object on spot. In all cases, it is important that the measuring instrument must be calibrated, because ultimately we want to match today's authentic metre unit to an earlier unit of length. It is also expected that the measured points are homogeneous, in a uniform reference system and that the RMS in the position of the detail points is within 5 mm.

As we only had a total station available, we used this technology and discuss it in more detail. Although this is routine technology in surveying, it has to meet a number of requirements, which are summarised below.

- 1) Choosing the right building to be analysed. This means that it is recommended to choose such a contemporary building that has survived in its original form, the foundation walls are easily identifiable, and the building itself is symmetrical and geometrically regular.
- 2) Identifying the main lines and points of the building to be measured. The key question of all surveys is what we intend to measure. In our case we surveying the elements that comprise the base geometry of the building.
- 3) Choosing the right measuring technology. For our surveying work we chose the technology of total stations – we presume its use from now on.
- 4) Inside and outside the building an accurate control survey network can be created with the aid of direction and distance measurement. It is also practical that we can decide which points we wish to measure, i.e. we need to measure the points which we find essential.
- 5) We need an accurate measurement of the control survey network based on direction and distance measurement both inside and outside the building and on more floors if necessary. Our aim is to provide a uniform, homogenous and accurate local coordinate system (whose x axis is the line connecting the centers of the two circles). Accurate measurement means that we set up all the tripods stable, with base plates, then we change the instrument and the prisms on the base plate to avoid positioning errors. As a result, we can provide a tailored, accurate horizontal (and vertical) network, which relative error is below 1/100000.
- 6) Detail points (points of observation) are to be measured precisely at the same time as the control points using the same measuring equipment. Since they are mostly building corner points, column corner points and arc points, where the positioning of a prism is not possible centrally, it is preformed using total station in reflectorless mode. A card should be placed on the point to be measured so that it is perpendicular to the direction line and the touchpoint (line) of the card and the building must be set by the measuring equipment. Clearly identifiable points are to be measured from two or more station positions.
- 7) Calculating the coordinates of the control survey network and the points for observation. The calculation of the coordinates of the geodetic control points must be carried out with

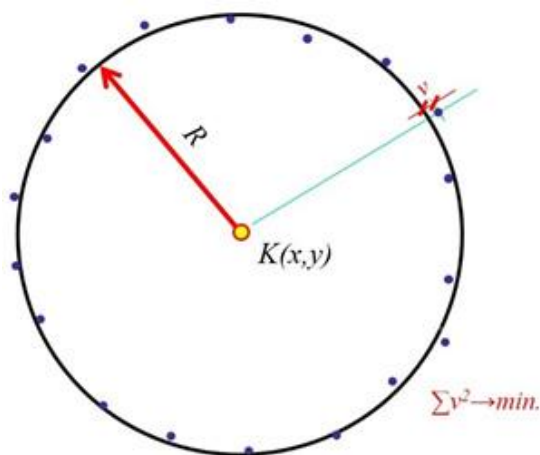

Fig.4. Regression circle

adjustment or else we cannot take into consideration all the measurements simultaneously and, therefore, the result will not be accurate. The coordinate deviations cannot exceed 3-5 mm. The calculation is to be done in a separate system as a free network to avoid frame errors that can influence the results. 8) Calculating the standard floor plan measures of the building. This calculation is carried out based on the measured points for observation using methods of coordinate geometry. Providing the standard data of the circles in terms of round churches is considered to be a separate task. A regression circle must

be fit to the measured points of the arcs according to the least squares method (*Fig. 4*). We will obtain not only the coordinates of the centre (K) and length of the radius (R) of the circle but also the standard deviation (*rms*) errors of them. Depending on the residuals (v) and deviations (*rms*) we are able to decide whether the building suits our purposes or not. Standard deviations are used for determining the weight of measures later on.

9) The floor plan is creating based on the performed geodetic measurements. The floor plan of the building is now ready to be constructed based on the points that have been measured and the calculated measurement data – in a metric system. The points (in the same vertical plane) that are on one line can be drawn as a regression line.

10) Matching standard building measurements to the former units of length. It is best to do this in a spreadsheet application. Now we have to decide whether the church was set up and built in a royal foot or in a royal span. We get the desired information after dividing the standard, metric building measurements by the 'official' metric length of the foot (0.313 m) and that of the span (0.195 m).

11) Constructing the floor plan using the former unit of length. We make a floor plan that is similar to what the original could have been where standard measures were given in integer (or half) multiples of the foot or span. It is really time-consuming and we may not succeed at once.

12) Recalculation the former unit of length. We need to make a table which includes both the standard distance data of the building given in metres and the unit of length in pieces. The metric value of the former unit, usually expressed as cm, is obtained from the quotient of the two data. We recommend a weighted average as an end result.

4 THE RECONSTRUCTION OF THE UNIT OF LENGTH BASED ON THE ACCURATE SIZE DETERMINATION OF THREE ROUND CHURCHES

In this chapter, as an example, we present one survey and the results from the measurements of three round churches. The workflow was described in details in Chapter 3.

4.1 The St. James chapel of Ják with four vaults

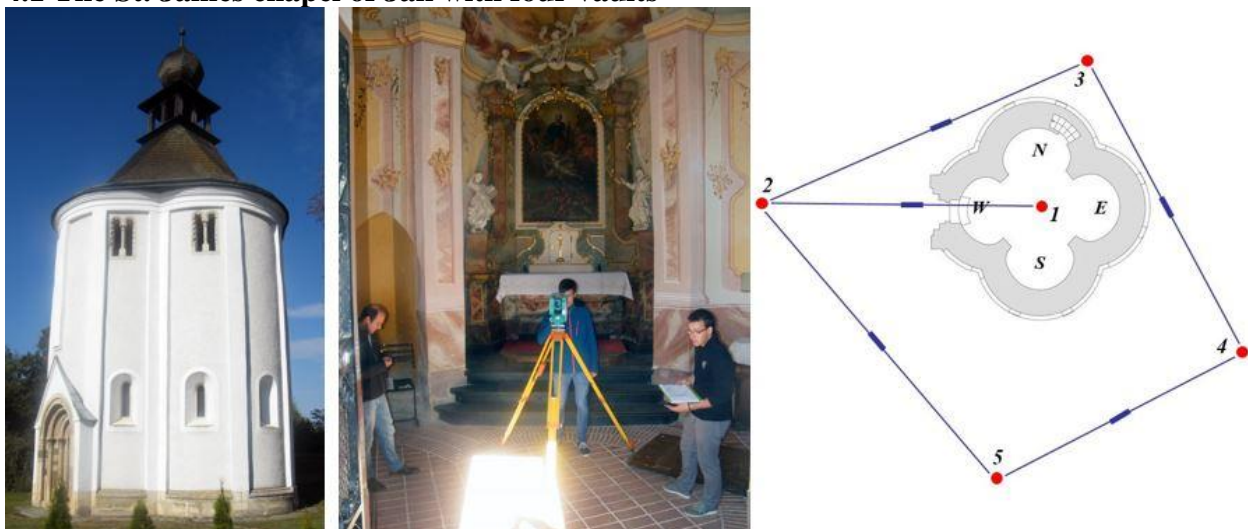

Fig. 5. The Ják chapel outside, inside and the sketch of control point network

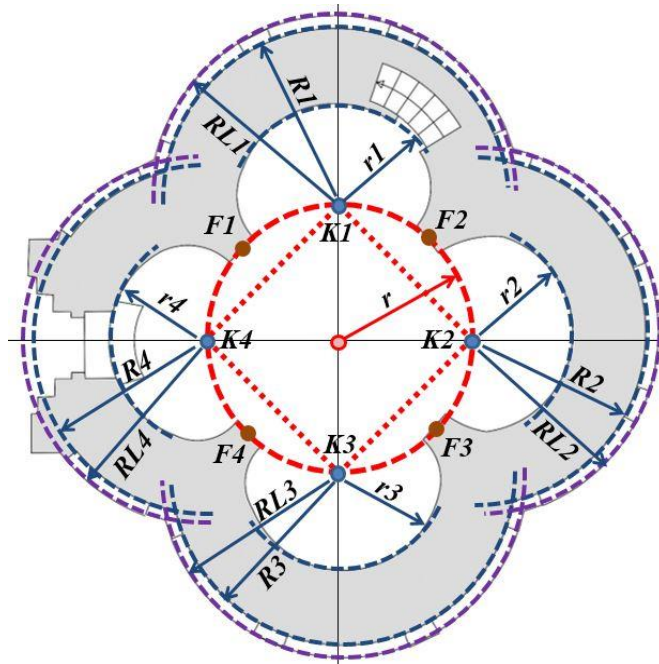

Fig.6. Notation the arches of the Ják church

We set up a control point network around the chapel with 5 control points (Fig. 5) and measured all detail points (in every metre sequentially), like it was described in Chapter 3.3. We identified 3 circles (arcs) in each vault (Fig. 6): the inner and outer wall points and the outer foundation points (12 arcs altogether). After it we calculated the center point coordinates and radii of these arcs (Table II). The standard deviations of these parameters are below 1 centimetre. Only one exception is the western arc, where a bigger rms is due to the front door, because the center points of these arches cannot be measured.

TABLE II. CIRCLE CENTER COORDINATES, RADIUSES AND THEIR RMS OF JÁK CHAPEL, ALL IN METRE

Description	Centre	y	x	notation	r	RMS y	RMS x	RMS r
1 st arc, inner wall	K1 (Nothern arc)	499.850	202.025	r1	1.492	0.010	0.019	0.009
1 st arc, outer wall		499.852	202.009	R1	2.620	0.002	0.007	0.002
1 st arc, foundation		499.848	202.014	RL1	2.815	0.002	0.005	0.001
2 nd arc, inner wall	K2 (Eastern arc)	502.046	200.183	r2	1.501	0.012	0.002	0.005
2 nd arc, outer wall		502.049	200.210	R2	2.603	0.007	0.002	0.002
2 nd arc, foundation		502.076	200.217	RL2	2.799	0.011	0.004	0.002
3 rd arc, inner wall	K3 (Southern arc)	500.208	198.014	r3	1.487	0.003	0.007	0.003
3 rd arc, outer wall		500.197	198.015	R3	2.607	0.003	0.009	0.003
3 rd arc, foundation		500.219	197.988	RL3	2.795	0.005	0.011	0.002
4 st arc, inner wall	K4 (Western arc)	498.078	199.844	r4	1.515	0.032	0.008	0.030
4 st arc, outer wall		498.050	199.843	R4	2.608	0.035	0.006	0.012
4 st arc, foundation		498.055	199.861	RL4	2.803	0.027	0.007	0.005

The centres (**K1**, **K2**, **K3**, **K4**) of different regression circles are mainly the same. These centres are corner points of the square. The **K1**-**K4** centres and the wall endpoints (**F1**-**F4**) are located on the same circle. What is the radius size of this circle? We find that the size of the radius is exactly 10 spans. All other radii we can determine in integral number of spans, for example the radius of foundation arc is 14 spans, the radius of outer wall is 13 spans, the radius of inner wall is 7 and half spans.

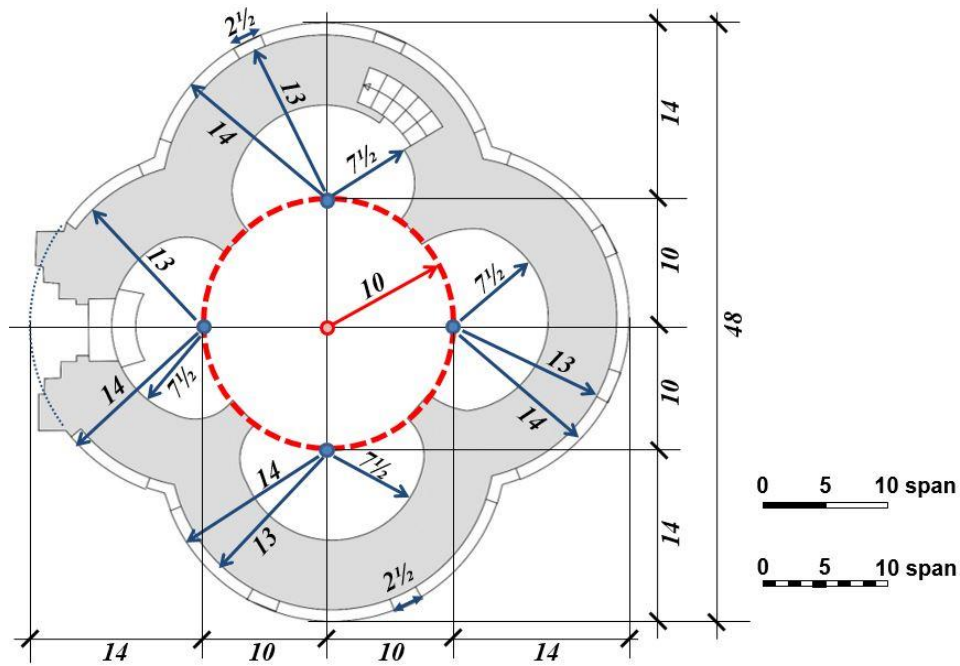

Fig. 7. The floor plan of Ják chapel in Hungarian span units

TABLE III. THE SIZES OF JÁK CHAPEL IN METRE AND SPAN UNITS

Description of sizes	no- tation	Distance (metre)	RMS (metre)	Pieces.	Span (cm)	Weight
1 st arc, } radius of inner wall (from 8 points)	<i>r1</i>	1.492	0.009	7.5	19.9	1
1 st arc, } radius of outer wall (from 12 points)	<i>R1</i>	2.620	0.002	13	20.2	2
1 st arc, } radius of foundation wall (from 16 points)	<i>RL1</i>	2.815	0.001	14	20.1	2
2 nd arc, } radius of inner wall (from 6 points)	<i>r2</i>	1.501	0.005	7.5	20.0	1
2 nd arc, } radius of outer wall (from 16 points)	<i>R2</i>	2.603	0.002	13	20.0	2
2 nd arc, } radius of foundation wall (from 16 points)	<i>RL2</i>	2.799	0.002	14	20.0	2
3 rd arc, } radius of inner wall (from 6 points)	<i>r3</i>	1.487	0.003	7.5	19.8	1
3 rd arc, } radius of outer wall (from 13 points)	<i>R3</i>	2.607	0.003	13	20.1	2
3 rd arc, } radius of foundation wall (from 17 points)	<i>RL3</i>	2.795	0.002	14	20.0	2
4 st arc, } radius of inner wall (from 6 points)	<i>r4</i>	1.515	0.030	7.5	20.2	1
4 st arc, } radius of outer wall (from 7 points)	<i>R4</i>	2.608	0.012	13	20.1	2
4 st arc, } radius of foundation wall (from 11 points)	<i>RL4</i>	2.803	0.005	14	20.0	2
Outer length of the church (East-West)	<i>K</i>			48	20.0	2
Outer length of the church (North-South)	<i>K</i>			48	20.1	2

The total length of this chapel is 48 spans, which is exactly 3 old Hungarian fathoms (Fig. 7). If we recalculate the span size from the measured metric size, knowing the above mentioned integer pieces, we get the span-size in centimetres (Table III.). At the end we get the weighted average length of the span unit: in case of Ják chapel this is 20.03 cm ±0.1 cm.

4.2 The St. Anne round church in Kallósd

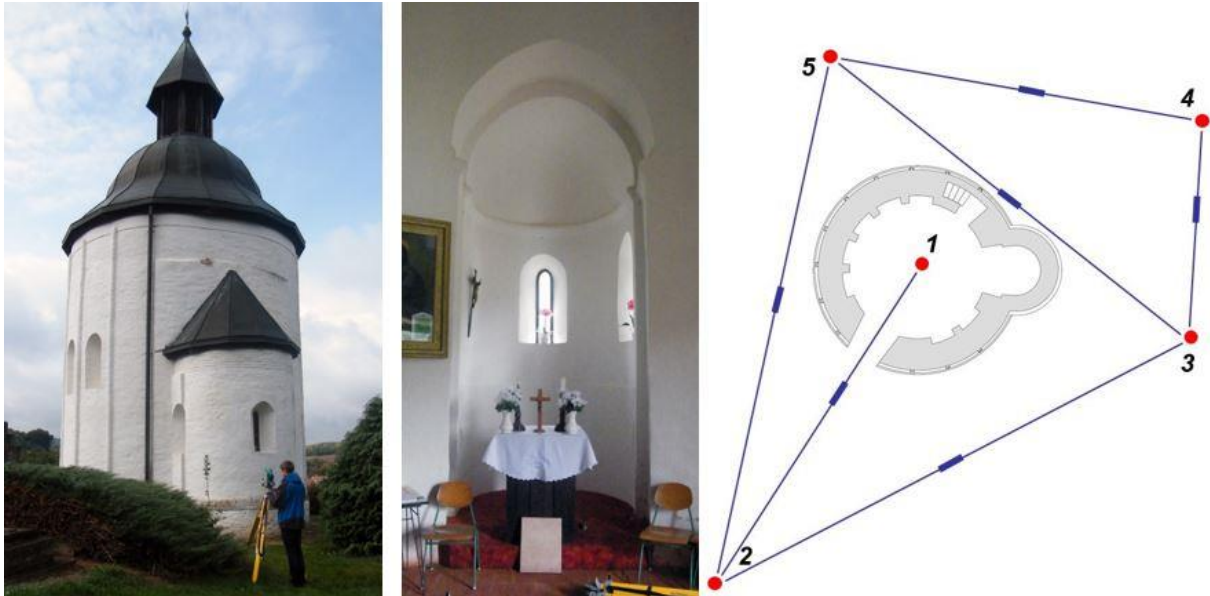

Fig. 8. The Kallósd round church outside, inside and the sketch of control point network

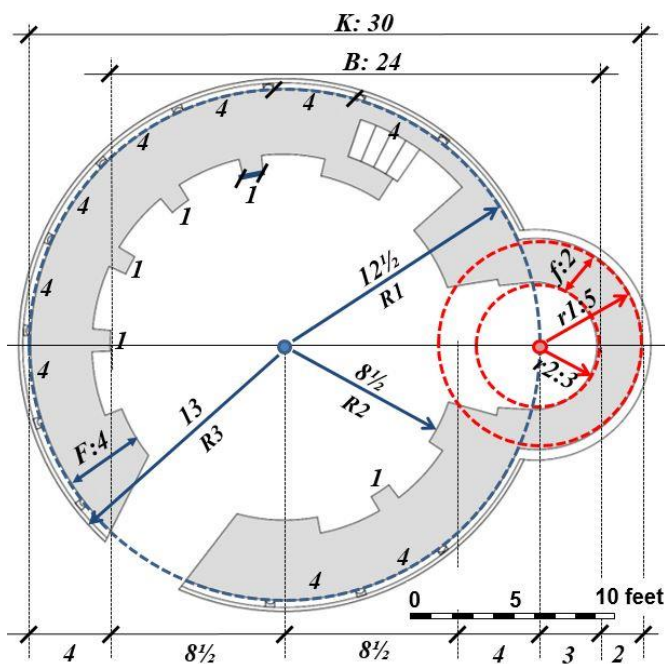

Fig.9. The Kallósd floor plan in Hungarian feet units

Kallósd church and found that all sizes are can be expressed as an integer multiple of a foot (Fig. 9). After calculation of the foot size from measured metric size, known the integer pieces, we get the foot-size in centimetres (Table IV.). The result for Hungarian foot is: 31.75 cm \pm 0.5 cm (Table IV.).

Kallósd is a small dead end village in Zala county. Its parish church was built around 1270 (Fig. 8).

The walls are built from brick. It means the identification of walls and measuring points are ideal for our purposes. There are seven sitting bays (niches) inside the nave. The other important details to be studied are the small columns outside the nave wall, called lesenes (pilaster strips). 9 of them are on the northern part (left to entrance) and 3 of them are on the southern part (right to entrance).

According to the applied procedure, given in Chapter 3.3, we reconstructed the floor plan of

TABLE IV. THE SIZES OF KALLÓSD CHURCH IN METER AND FOOT UNITS

Description of sizes	notation	Distance (metre)	RMS (metre)	Pieces	Foot (cm)	Weight
Outer radius of nave (from 20 points)	R1	3.937	0.003	12.5	31.5	3
Inner radius of nave (from 20 points)	R2	2.671	0.003	8.5	31.4	3
Outer radius of sanctuary (from 8 points)	r1	1.627	0.006	5	32.5	2
Inner radius of sanctuary (from 6 points)	r2	0.980	0.012	3	32.7	1
Outer length of the church ($2R1+r1$)	K	9.501	0.008	30	31.7	2
Inner length of the church ($2R2+F+r2$)	B	7.588	0.019	24	31.6	2
Thickness of nave wall ($R1-R2$)	F	1.266	0.005	4	31.6	2
Thickness of sanctuary wall ($r1-r2$)	f	0.647	0.014	2	32.4	1
Lesene width (12)		0.155	0.002	0.5	31.0	1
Distance between lesenes (10)		1.267	0.003	4	31.7	1
Radial size of lesenes (2×12)		0.101	0.004	0.3125	32.3	1
Column width at sitting niches (5)		0.314	0.002	1	31.4	1

4.3 The St. Nicholas round church in Selo (Slovenia)



Fig. 10. The Selo rotunda outside, inside and the sketch of control point network

This round church is situated close to the Hungarian-Slovenian border (Fig. 10.). It was first mentioned in the middle of the 13th century but its origins are earlier. The church is famous for its wall paintings (their fragments are seen in the niches and in the cupola). The basic wall is made from volcanic tuff and the walls from bricks. It is important to mention that only the nave remained in its original form, as the apse was demolished, replaced by a tower, and in 1956 it was rebuilt. This is the reason that the sizes of the apse were omitted from our study (Fig. 11.). Eight circles were identified and the radii of these regression circles determined from points recorded per meter were included in the reconstruction Table V. At the end we get the weighted average of span: in case of Selo round church this is 19.93 cm \pm 0.2 cm.

TABLE V. THE SIZES OF SELO ROUND CHURCH IN METER AND SPAN UNITS

Description of sizes	no- tation	Distance (metre)	RMS (metre)	Pieces	Span (cm)	Weight
Radius of nave lesenes (from 43 points)	R1	4.271	0.002	21.5	19.9	2
Radius of nave foundation wall (from 48 points)	R2	4.383	0.002	22	20.0	2
Outer radius of nave wall (from 41 points)	R3	4.203	0.001	21	20.0	2
Inner radius of nave wall, below (from 26 points)	R4	3.297	0.001	16.5	20.0	2
Inner radius of nave wall, above (from 10 points)	R5	3.308	0.002	16.5	20.1	1
Radius of sitting bays, above (from 10 points)	R6	3.555	0.002	18	19.8	1
Radius of sitting bays, below (from 10 points)	R7	3.547	0.003	18	19.7	1
Radius of cupola (from 14 points)	R8	3.310	0.004	16.5	20.1	1

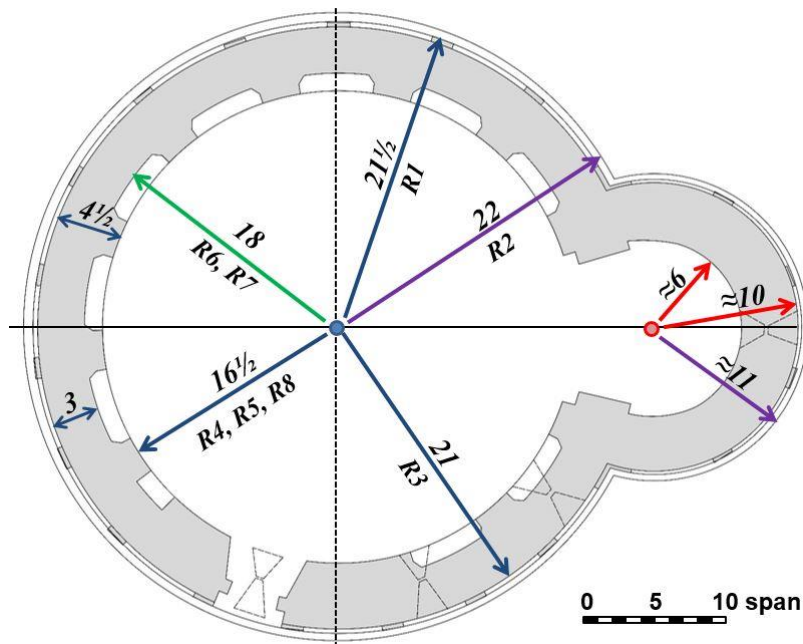

Fig. 11. The floor plan of Selo church in Hungarian span units

Since the 3 control points were measured using RTK GNSS technology also, the orientation of the round church can be determined in the ETRS89 system, not only in local system. The direction of the line connecting the center of the two circles (which is original west-east direction at the time of construction) differs by only 3 degrees.

5 CONCLUSIONS

An accurate building survey is based on an accurate geodetic control point network inside and outside the building. The relative error of the control point network for all buildings surveyed so far has been around 1/100000. All distance residuals were under 2 mm and all angular residuals were under 7 seconds. The standard deviation of the regression circles is also surprisingly small: usually less than 1 cm. This means that not only our surveying was good, but also that the builders and surveyors of the time worked accurately and carefully.

In our study we measured the sizes of seven round churches from the Medieval Ages and redrew the floor plan of these buildings. The dimensions of only three of these seven objects are given in more detail in Chapter 4 due to space constraints. The dimensions were first given in metres but later in the ancient unit of length. These floor plans were used to recalculate the size of the royal fathom in metres. We used all the sizes and calculated the weighted mean for all buildings (Table VI).

TABLE VI. THE SUMMARY OF THE RESULTS OF THE MEDIEVAL ETALON RECONSTRUCTION

Church from Medieval Ages, settlement	Span (cm)	Foot (cm)	RMS (cm)	Fathom (metre)
Saint Anne Chapel (Székesfehérvár)		31.84	0.3	3.184
Saint Anne Round Church (Kallósd)		31.75	0.5	3.175
Saint Paul Round Church (Bagod)		31.96	0.3	3.196
Saint James Chapel (Ják)	20.03		0.1	3.205
Church of Blessed Virgin (Tarnaszentmária)		31.70	0.5	3.170
12 Apostles Rotunda (Bíňa, Slovakia)	19.90		0.1	3.184
Saint Nicholas Round Church (Selo, Slovenia)	19.93		0.2	3.189

We successfully reconstructed the earlier original unit of length in the metric system. As per our calculations the Hungarian royal fathom (10 feet) equals 3.186 metres instead of the earlier ‘official’ value of 3.126 metres. Therefore, the length of 1 Hungarian foot is 31.9 centimetres, the length of 1 king's span is 19.9 centimetres, the length of 1 king's ell is 63.7 centimetres, 1 inch is 2.66 centimetres and the length of a finger is 1.99 centimetres. Our reconstruction method to obtain conversion factors were thus confirmed.

We have not been able to go into all the details in this article, but our study can be downloaded in book form (in Hungarian) [3].

REFERENCES

- [1] Bogdán István: Magyarországi hossz- és földmértékek a XVI. század végéig. (*Length and squares measures in Hungary until the end of XVI. century*). Akadémiai Kiadó, Budapest, 1978. p 388.
- [2] Alán Kralovánszky: *The Earliest Church of Alba Civitas*. Alba Regia, Székesfehérvár, 1983, Vol. XX. pp. 75-88.
- [3] Busics György – Tóth Sándor: A királyi öl hossza. (*The lengths of the royal fathom*). Magyarországi Kutató Intézet, Budapest, 2020. p 232. <https://mek.oszk.hu/21500/21587/>

BIOGRAPHICAL NOTES

György BUSICS was born in 1953 in Szombathely, Hungary. He attended the Land Surveying Branch of the Budapest Technical University. From 1977 he was working as a land surveyor at the local offices of the State Enterprise of Cartography for four years, where he took part in large-scale mapping. He started to work at the College of Geoinformatics in Székesfehérvár (now belongs to the Óbuda University) in 1981 and he has been teaching and researching here

until 2018, when he retired. He was the head of the surveying department and responsible for the following subjects: Geodetic Networks, Satellite Positioning, Quality Management. He takes an active part in the Hungarian application of the GNSS technique. He has long been interested in the history of the medieval unit of length, and in 2020 the book co-authored with his student was published. He is a member of the Geodetic Committee under Hungarian Academy of Sciences and fellow of the Hungarian Society of Surveying, Mapping and Remote Sensing.

Sándor TÓTH was born in 1992 in Hódmezővásárhely, Hungary. First he graduated as a geographer (from Szeged University), then as a land surveyor (from Székesfehérvár), later as a surveyor and GIS engineer (from TU Budapest). During his BSc studies at Székesfehérvár György Busics, the first author of this paper mentored him and turned his attention to the medieval unit of length. Now he is working at the Lechner Ltd. Satellite Geodetic Observatory (SGO), Péc. He has a great experience with surveying field work and GNSS data analysis. He is participating in EUREF Permanent Network (EPN) densification. His main tasks are related to GNSS meta-data analysis and harmonization. His research activities are in the field of quasi-geoid determination, deformation modelling, height reference system maintenance. He is also a member of the K-GEO Accredited Calibration Laboratory. He is preparing his PhD studies.

CONTACTS

György Busics
Óbuda University Alba Regia Technical Faculty Institute of Geoinformatics
1-3. Pirosalma street
Székesfehérvár
HUNGARY
Tel. +36 22 200412
Email: busics.gyorgy@amk.uni-obuda.hu
Web site: <https://www.amk.uni-obuda.hu>

Sándor Tóth
Lechner Nonprofit Ltd. - Satellite Geodetic Observatory
2614 Péc
HUNGARY
Tel. +36 27 200807
Email: sandor.toth@lechnerkozpont.hu
Web site: <https://www.sgo-penc.hu>