

Response Evaluation of Steel Frame systems with Settlement Load Under Seismic Excitation using Structural Health Monitoring

(10934)

Hasan SHAHRIYER, Mosbeh R.KALOOP, Jong-Wan HU



Presented by: Mosbeh R.Kalooop, PhD

Dept. of Civil & Environmental Engineering

Incheon Disaster Prevention Research Center, Incheon National University, Korea

Date: June 23, 2021

Presented at the FIG e-Working Week 2021,
21-25 June 2021 in Virtually the Netherlands

Content

1

Introduction and Research Motivation

2

Literature Review

3

Experimental Design

4

Results and Discussion

5

Conclusions and Recommendations

Introduction and Research Motivation

Structural engineers initially simplify the load condition, use their engineering judgment, and come up with a solution that may fulfill the requirement. During construction or post-construction state, the structure may undergo deformation, lost stiffness, experience artificial vibration, foundation settlement in terms of displacement or earthquake excitation. If the structure cannot survive under those loads, we may call the structure is damaged. Internal stress within the member plays an important part in the stability and rigidity of the frame whose performance may fluctuate due to above circumstances. At present, structural engineers usually neglect any influence caused by vertical displacement of supporting columns over the structure during their design stage or post-construction stage which is very conservative although it may help to avoid complex calculations.

Also it's been inevitable for any structure to undergo changes due to presence of corrosion, degradation of the component or the loss of stiffness at the joint over the service life also sudden heavy load like earthquake, tsunami, cyclone, etc. may aggravated the health condition of the structure and may resulting into loss of life and property. In this circumstance Structural Health Monitoring (SHM) system provides the necessary information for the user and may help to understand the up to date condition of the building in a suitable manner.

Therefore, this research investigates to study the response of a three-story steel frame model under 10mm differential displacement/settlement condition having damage and healthy case over fixed seismic linear actuator. Here damage and health case represent as loosened and tightened bolted connections at one side of the support system.

Literature Review



Seismic damage

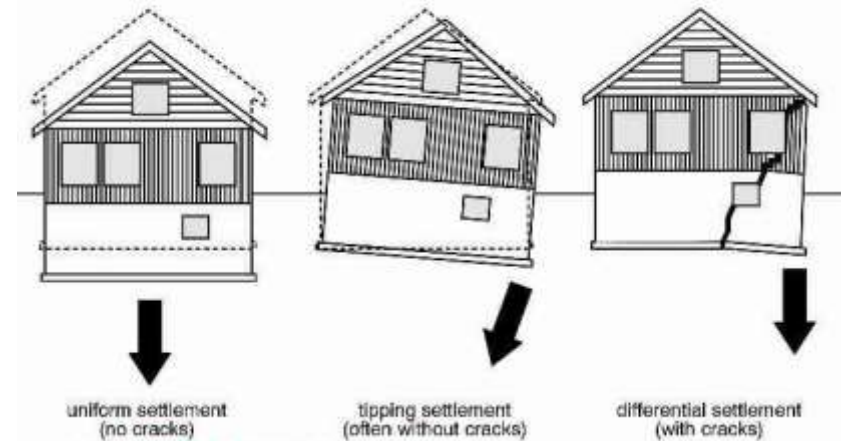

Settlement effects

Recently, Several structures health monitoring (SHM) systems have been widely used to guide the engineers to monitor structures members to detect damage as well as help to reduces the cost of quality control, minimizes the production time and improve in design process which results into a suitable structural management system

Experimental Design

Prefabricated three storey shear building frame model shown in Fig-1 made from SUS304 stainless steel. The composition consists of a column member (0.110kg), a floor member (1.8kg), and a member (0.050kg) that holds the two. The frame is designed in such a way that three story frame model have three degree of freedom system. To collect the response data from frame system iLOG-ACC-MEMS-WNN-3CH sensor has been used which can provide acceleration data in 3 direction at 150 & 200Hz by using Wi-Fi-system.

Two sensors have been installed in the frame model, one was supported at the top floor, another in the base of the hydraulic actuator to collect the input seismic data.

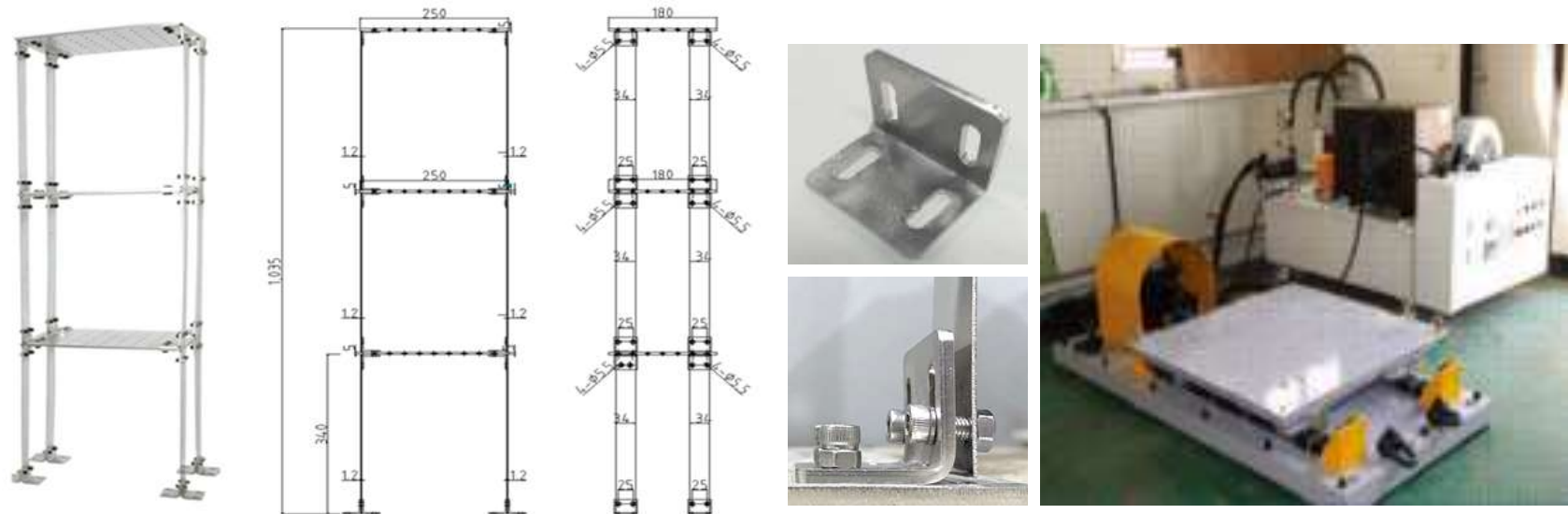

Fig.1: Three-Dimensional Frame Building (units are in mm), Adjustable Angle, Damage Condition, Hydraulic Actuator

Experimental Design



Results and Discussion

The input earthquake has been shown in the Figure 2 which has been filtered through 2nd order Butterworth Bandpass filter. The filter was considered to pass and stop band frequency 0.1 to 70Hz, respectively.

Dominant frequency of healthy frame under seismic vibration is 1.5625Hz and exhibit 0.8601g acceleration at top which reduce to 1.4895Hz and 0.7501g respectively under settlement condition.

This situation aggravated substantial due to the presence of damage where frame demonstrate 1.2695Hz frequency and 0.5275g acceleration under damage and no settlement situation.

Damage and settlement together shows 1.1719Hz frequency and 0.4675g acceleration which is the most lowest scenario case from the above cases.

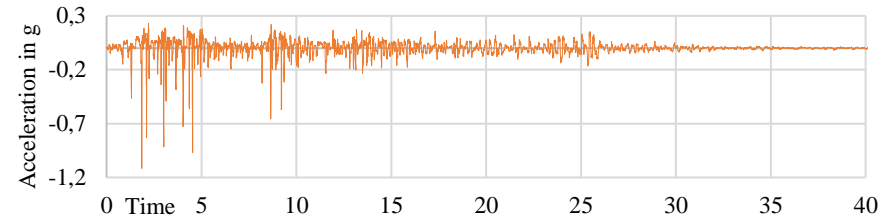

Figure 2. Input Earthquake Acceleration

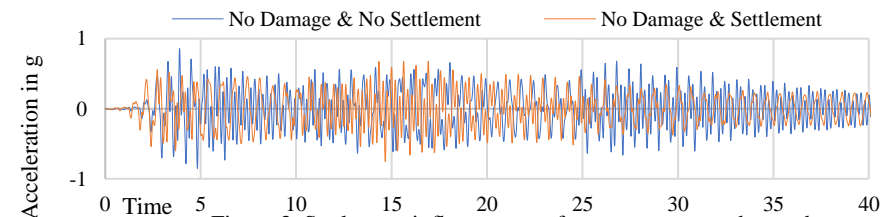

Figure 3. Settlement influence over frame response under no damage condition

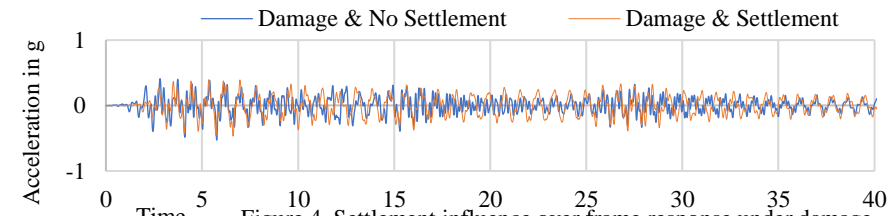

Figure 4. Settlement influence over frame response under damage condition

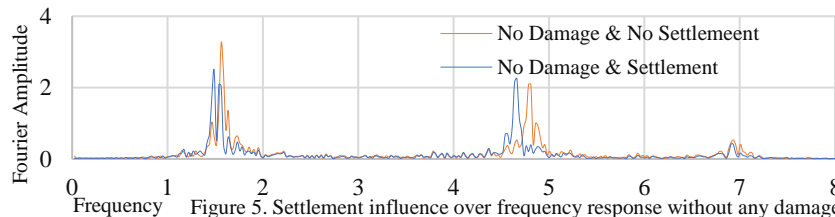

Figure 5. Settlement influence over frequency response without any damage

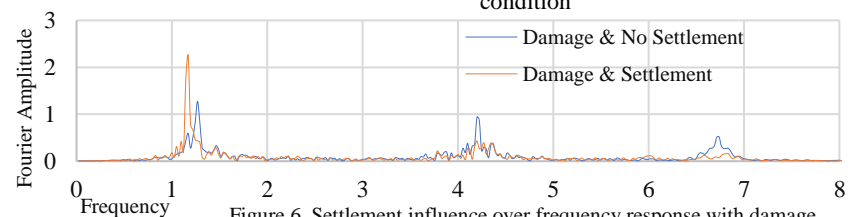

Figure 6. Settlement influence over frequency response with damage

Conclusions and Recommendations

From experimental data, it can be easily understood that settlement in terms of displacement and damage as a result of loss of tightness of bolted joints at base of the column have influence over response of the frame model. Due to settlement the response of the frame has slightly changes from healthy structure. Frame response under damage condition have higher influence over settlement state. Under the damage condition like loss of tightness of the bolt at base level create more frequency loss compare to only settlement condition. If both conditions have been considered it has been found that response of the frame will decrease higher which means either damage or settlement frame system possess damage in the system of the frame model.

In real-world building where settlement impact often ignored to avoid the complex calculation which should not be neglect as it has sufficient influence over this prototype building frame model. Also presence of damage significantly reduces the frame response and existence of both show more loss of the integrity in the building frame model.

Thank You

Any Question ?