

**Hartmut Müller**  
**i3mainz**  
**Institute for Spatial Information and Surveying Technology**  
**FH Mainz**  
**University of Applied Sciences**  
**Holzstr. 36, D-55116 Mainz, Germany**

## **Some Samples of Modelling and Presenting Three-dimensional Spatial Objects**

### **Abstract**

Three-dimensional spatial data are needed in many application areas. The integrated three-dimensional processing of complete spatial objects becomes the more and more important and is expected to supersede the currently widely used separate planar/height processing techniques in the not too far future. The paper deals with some aspects of the construction of three-dimensional virtual scenes and with their animated presentation. Examples are given to illustrate the various occurring tasks and the techniques used to find appropriate solutions under different conditions.

### **1. Introduction**

When transforming real world objects into virtual ones, many aspects have to be considered. The geometric and the semantic properties of the objects have to be analysed, the data situation has to be observed, the users' needs have to be explored etc. Regularly, we have to do with a conflict between accuracy and economy: if we use a highly sophisticated model to describe the objects geometrically and semantically, this inevitably will result in bigger efforts for data acquisition, in higher data volumes and normally in a lower performance than when using a simpler model. Therefore, the balance between accuracy and economy has to be found individually in all projects.

The following sections describe several projects which all were targeted on object modelling, on data acquisition and on data presentation for closed areas of manageable size. The modelling process, mainly focussing on geometrical modelling, always was done in close cooperation with the different users to fulfil their requirements. At the same time we tried to keep the expenses (man power, data volumes, etc.) on an acceptable level. Depending on the kind of object, different data acquisition methods (working up historical documents, in situ photogrammetric and tacheometric data acquisition) were used. Photo-realistic real-time visualisation often has to struggle against large data volumes. That is why currently in many cases the animation of the 3D objects is restricted to playback of recorded animation sequences, which the user can run in one predefined way. Interactive functions, like changing the view point, walking or flying through the digital landscape, etc., are also available but not always applicable. The way in which the presentation was done for all projects is discussed below.

### **2. Man-made Objects**

#### **2.1 A modern road scene**

Regional and urban planners, decision makers and all interested citizens benefit considerably from vivid graphical presentations of planned situations before those situations will become reality. Creating presentations of future scenarios needs the current situation as a substantial input. As an example for the conversion of an existing scene into a feasible digital form the village Evolene in the Swiss Alps was transformed into a digital model (Mueller, 1997). Foerstner (1999, p.291) states: "There is no commonly accepted model for the object 'building'". The main purpose of the data set under consideration was to serve as a base for animated presentations. Generally speaking, realistic looking surface textures are more important for such presentations than detailed geometric descriptions of the buildings are. It was decided to use a rectangular solid with a prism put on the top surface of the solid (see Figure 1) to geometrically model all buildings in the same simple way. In this model, the values of four parameters length, width, height and roof top height describe the shape of a building completely. The parameter values were determined from aerial images by applying conventional photogrammetric methods. The texture of the building facades was taken from terrestrial images by means of interactive rectification. Figure 2 shows a terrestrial image and one single image of an animated image sequence which consists of about 1000 images presenting main road of the village as a whole.

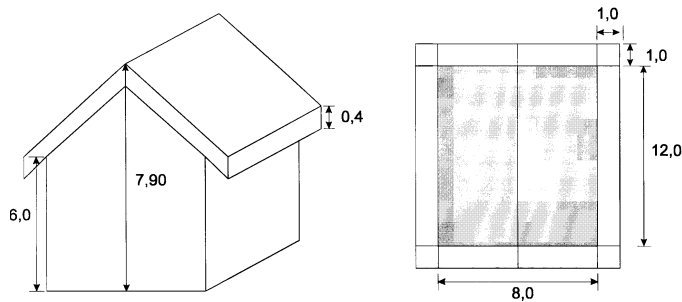

Figure 1 Parametric geometric building model

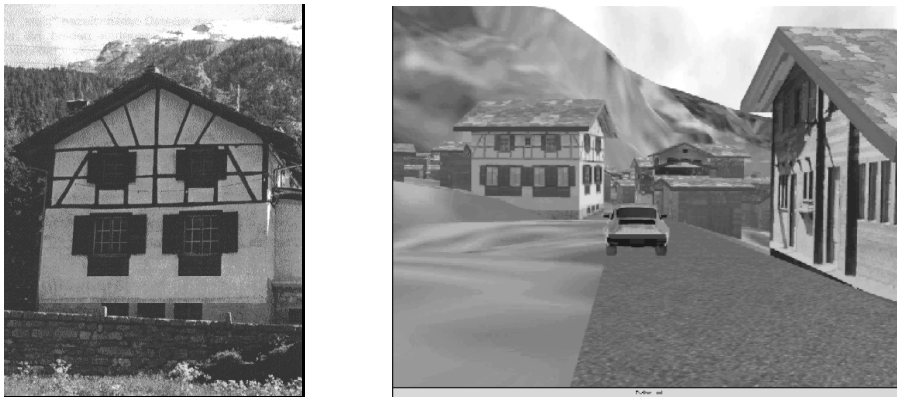

Figure 2 Facade photography and video clip screenshot

## 2.2 A historical road scene

Historical research projects often deal with objects which can not be seen in reality because they already disappeared. In such cases, virtually reconstructed objects help historians to improve their imagination of those objects, which again helps them to create and to prove new scientific ideas. The main street of the ancient settlement Burtscheid near by the German city Aachen was an important centre of cloth manufacturing industries in the 18<sup>th</sup> century and, therefore, it is an outstanding source for historical research. Almost all of the historical buildings of this street were destroyed during the second world war. The historical road scene was reconstructed digitally in the computer. Old sketches, maps, drawings and images were used to compare the ancient scene with the modern rebuilt scene and to create a virtual model of the historical scene in the computer (Simon, 2000). Exploring and combining old and new documents was the major challenge in this project.

The historical ensemble to be reconstructed consists in all of about 85 buildings. Five of them had survived the second world war and those are the only ones which are still present in their original form. Ground-plan sketches dated from 1832 were available to document the situation given at that time (see Figure 3). Those sketches served as a base for the digital reconstruction of the buildings' ground-plans. True to scale drawings of the building fronts were done between 1910 and 1914 by Joseph Crumbach (see Figure 4). Checking these drawings against the geometric shape of the five still existing buildings proved the good geometric drawing quality. That is why it was possible to map the building faces onto the true to scale ground-plan as generated from the sketches by 1832. The road rises with a gradient of about 10 percent, a fact, which determines the visual impression of the road course considerably. Therefore, it was necessary to consider also the height component of the road course. This was done by checking the longitudinal sections as taken from the Crumbach drawings against the height courses as obtained from current sewer documentation plans. The results of this procedure proved a good coincidence of the corresponding sections. Consequently, the hypothesis was adopted that the road heights essentially were kept unchanged over time. Animated image sequences of the road ensemble were generated; Figure 5 shows a single image which is part of such an image sequence.



Figure 3 Ground-plan sketch of the surveying campaign by 1826

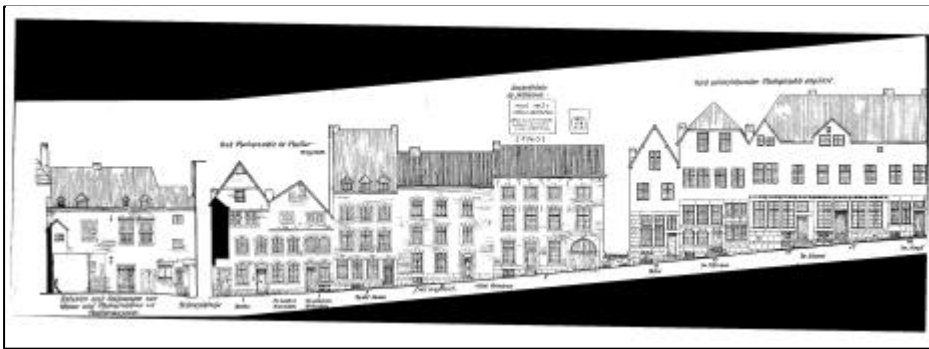

Figure 4 True to scale front view (original drawing on a scale of 1:100)

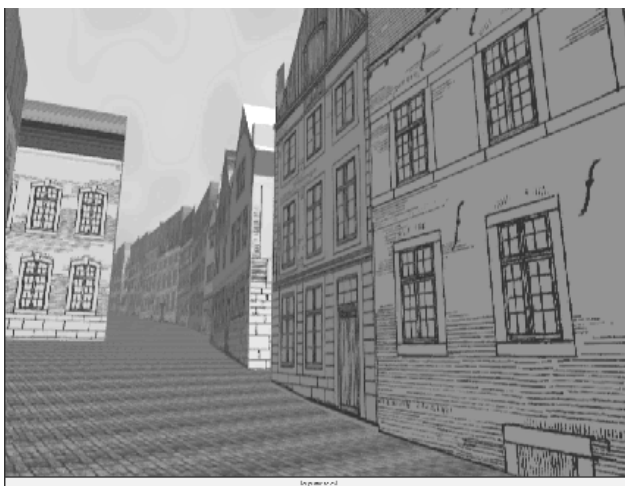

Figure 5 Screenshot of the digitally rebuilt ancient road scene

### 2.3 The Archaeological Excavation Site under Cologne Cathedral

Cologne Cathedral, part of the UNESCO world heritage, is the largest ecclesiastical building in Germany with about two million visitors every year. The present cathedral (Figure 6) was built on the ruins of several predecessors. Archbishop Konrad von Hochstaden laid its foundation stone in 1248. Building activities continued until 1560. After a long break work on the Cathedral was resumed in 1823. The body of the church had been completed by 1863 and the towers were finished by 1880. Archaeologists and historians are strongly interested in many details of the long and rich building history. After the second world war an archaeological excavation site (see Figure 7) was established

under the cathedral to endeavour and to document the relics of the previous buildings, to document the foundations of the current gothic building and to perform much other scientific work.



Figure 6 Cologne Cathedral overground view



Figure 7 Cologne Cathedral underground view



Figure 8 Geometric surface modelling

Often, the focus of ancient building activities was not to build up the objects in a geometrically well defined way as this is normally done today. Geometric modelling procedures, however, rely strictly on geometric primitives like straight lines, flat surfaces, etc. (see Figure 8). To meet the users' requirements in such cases and to keep, at the same time, the expenses for the acquisition and the management of the digital data at a reasonable level, a sound strategy for the surface modelling process has to be developed in close cooperation with the archaeological and other professionals. Figure 9 shows a visible detail of the foundations of Cologne Cathedral as appearing in reality and the presentation of the same detail as generated from the digital data set. Real world coordinates of prominent object points served as input data to build up 3D faces which describe the objects digitally. The main purpose of the digital object model is to serve as a highly accurate framework for detailed investigations of single objects already performed or planned by the archaeologists. The model provides for natural control points which form a frame work of high quality for subsequent work. In that way, measurements performed by using simple surveying equipment like strings, folding rules, spirit levels, etc., can be transformed into the overall digital model of the complete cathedral without losing accuracy.

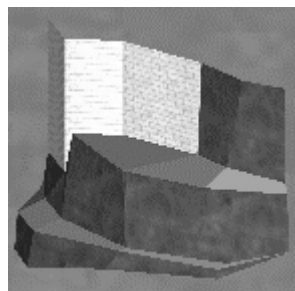

Figure 9 Real world object and geometric model

The real world object coordinates of prominent points at the gothic foundations were determined by using conventional electronic tacheometric surveying methods. A reference frame consisting of a point set covering the whole excavation area and establishing the geodetic reference with a  $\pm 2$  mm accuracy served as an accurate base for the surveying campaign. About 2000 points were measured (Franke and Roemmelt, 2000) from which the digital model of the foundations of the present gothic style Cologne Cathedral was created. Figure 10 shows a part of that digital model limited to the visible parts of the foundations. The lower limitation of the model is given by the depth of the excavation as reached so far. A concrete ceiling which is needed to support the overground interior parts of the cathedral (compare with Figure 7) forms the upper limitation of the visible parts. The flat top surfaces of the model denote the intersecting planes of the foundations and that ceiling.

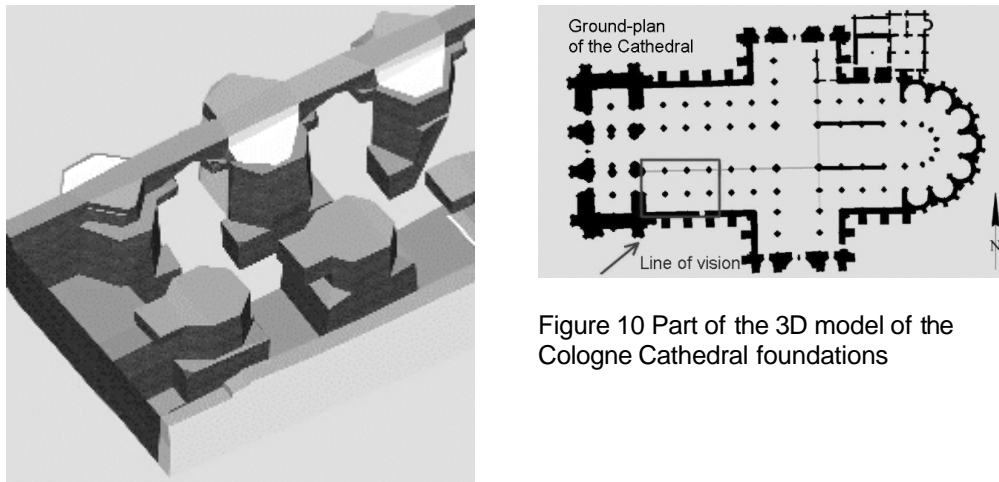

Figure 10 Part of the 3D model of the Cologne Cathedral foundations

### 3. Natural Surfaces – A Geological Monument

A breakers cliff of the Oligozaean sea situated about 50 kilometres south of the German city Mainz has been preserved over 35 million years until today. The cliff is a very important geological monument, which is almost unique in Europe. A digital model of the cliff was created to serve as a base for scientific geological analysis as well as for public relation purposes. The cliff surface was completely captured at a high geometric resolution and precision level. Photogrammetric and geodetic techniques were used for spatial data capture (Boochs et al, 2000, Rode and Sachreiter, 1999). The photogrammetric images were taken from a helicopter with a conventional analogue medium size measuring camera. The images were scanned with a high precision scanning device at a  $14 \mu\text{m}$  resolution to prepare them for digital image processing. The absolute orientation of the images was done by using terrestrial control points which had been connected by GPS measurements with the official national planar and height coordinate reference systems. The results of the aerotriangulation process proved the positional accuracy to be within the 1 cm range in the centre parts containing the cliff of  $70 \text{ m} \times 40 \text{ m} \times 15 \text{ m}$  size and to decrease at the borders of the measuring area slightly down to 2 to 3 cm. To enable detailed scientific analysis the geologists required the final digital object model at a very high resolution level. About 500.000 three-dimensional points were created by using automated image correlation methods. That number of points corresponds with a 10 cm point interval in the object space. Figure 11 explains how the correlation method works: a window of  $3 \times 3$  pixel size in the left photograph of a photogrammetric model serves as a reference window for the correlation process. Another window of the same size is moved over the right photograph until the maximum degree of coincidence of the pixels' grey values in both windows is reached. In that way, the corresponding image points are found automatically. Manual interactions of an operator are only needed to eliminate possible outliers. If the pre-processing steps are done in an appropriate way the error rate usually can be kept below 1 to 3 percent.

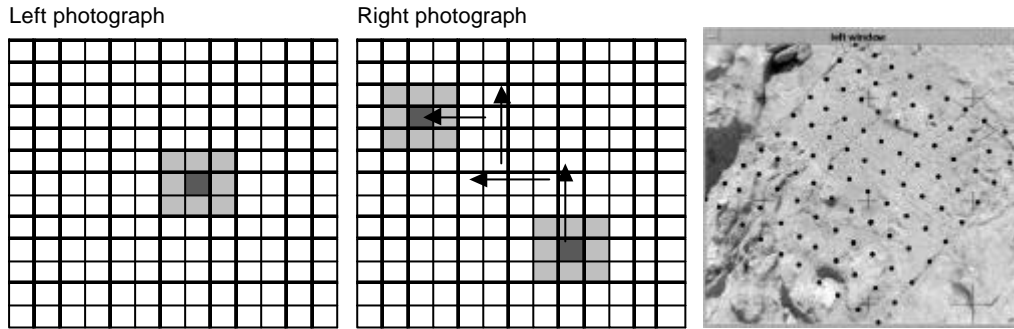

Figure 11 Automatic 3D object model generation

Despite the ever growing computer capabilities large data volumes still often prevent users from working interactively with huge data sets. A special software was developed to support the users when creating views of the cliff on the computer screen interactively (Boochs et al, 1998, Wolter, 1997). The geometrical base for all visualisation processes is a triangular irregular network (TIN), see Figure 12. To make the near real time visualisation possible, the processing is split into two steps. The system provides, in a first step, for a simplified object presentation in a small preview window (see Figure 13) to let the user control the visualisation parameters, like view point, viewing angles, zoom factor, interactively in true real time. In the second step, the view is generated in the main window, which may take some time, typically in the sub-minute range. The software features comprise the presentation of point clouds, of illuminated triangles, texture mapping and, visualisation of attribute information. Currently, the software runs only under UNIX operating systems.

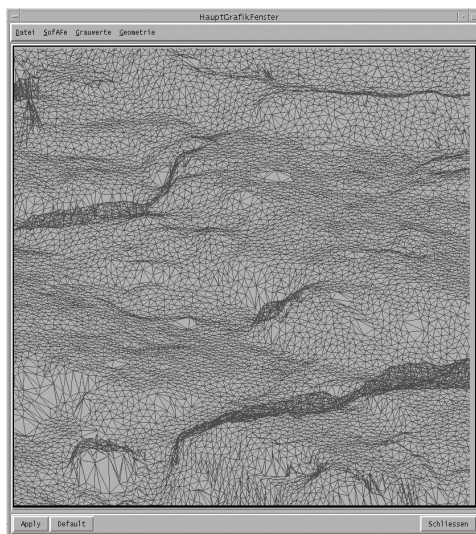

Figure 12 Triangular Irregular Network as the geometric visualisation base

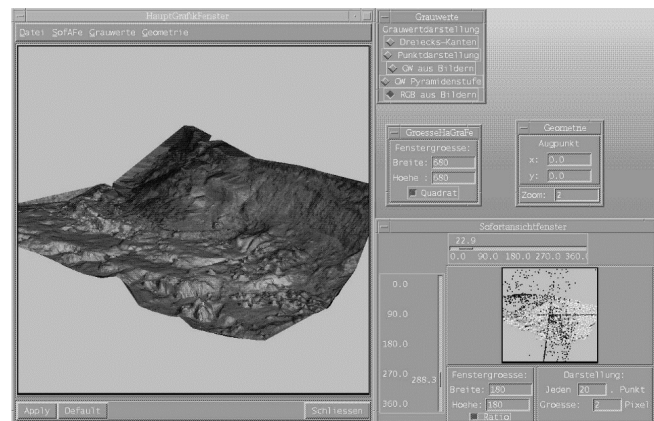

Figure 13 Graphical user interface of the 3D visualisation software

#### 4. Conclusions

Many aspects have to be considered when dealing with true 3D spatial data processing. The availability of data has to be checked, the quality of those data has to be proved, in situ data acquisition methods have to be mastered, data modelling strategies and appropriate presentation methods have to be developed. In many cases, a certain similarity with the corresponding 2D tasks has to be noticed. However, the degree of complexity is regularly much higher in 3D.

#### References

- Boochs, F., Emmermann, K.-H., Mueller, H. (2000): Bestimmung eines detaillierten Objektmodelles eines fossilen Brandungskliffs und seine interaktive realistische Visualisierung. In: Strobl /Blaschke /Griesebner (Ed.s), Angewandte Geographische Informationsverarbeitung XII, Beiträge zum AGIT-Symposium Salzburg 2000, Herbert Wichmann, Heidelberg, 2000, pp. 55-60.
- Boochs, F., Garnica, C., Wolter, F.( 1998): Determination and Interactive Visualisation of 3D-Objects.. International Archives of Photogrammetry and Remote Sensing, Vol. XXXII, Part 5.
- Förstner, W. (1999): 3D-City Models: Automatic and Semiautomatic Acquisition Methods. In: Dieter Fritsch / Rudolf Spiller (Eds.), Photogrammetric Week '99, Wichmann, Heidelberg, 1999, pp. 291-303.
- Franke, S., Roemmelt, C. (2000): Dokumentation der gotischen Fundamente des Kölner Domes. Fachhochschule Mainz – University of Applied Sciences, Diploma thesis, unpublished.
- Mueller, Natalie (1997): Herstellung eines 3D-Modells für eine Simulation auf dem Gebiet der virtuellen Realität. Fachhochschule Mainz – University of Applied Sciences, Diploma thesis, unpublished.
- Rode, K., Sachreiter, J. (1999): Digital-photogrammetrische Vermessung eines Geotops und Erstellung einer pseudorealistischen Visualisierung. Fachhochschule Mainz – University of Applied Sciences, Diploma thesis, unpublished.
- Simon, T. (2000): Digitale Rekonstruktion einer historischen Straße. Fachhochschule Mainz – University of Applied Sciences, Diploma thesis, unpublished.
- Wolter, F. (1997): Visualisierung einer geschlossenen Oberfläche mit OpenGL, Fachhochschule Mainz – University of Applied Sciences, Diploma thesis, unpublished.